

**GRABER.** | DELIGHT IN  
EVERY DETAIL

Graber Natural Shades  
US Price Guide

January 2026

## Product Information Guide

### Features

Natural Shades, Natural Drapes . . . . .	2
The Beauty of Natural Shades . . . . .	3
Material Styles and Information: Natural Shades and Natural Drapes . . . . .	4-5

### Size Considerations

Natural Shades: Depth Requirements for Inside Mount . . . . .	6
Natural Drapes: Depth Requirements for Inside Mount . . . . .	6

### Options

Summary . . . . .	7
Continuous Loop Lift: Natural Shades, Cordless Lift: Natural Shades . . . . .	8
Motorized Lift: Natural Shades . . . . .	9
Control Options & Fullness: Natural Drapes . . . . .	10
Liners: Natural Shades & Natural Drapes, Edge Banding and Colors: Natural Shades & Natural Drapes . . . . .	11
Cut-Outs: Natural Shades, Non-Operational Angled-Top: Natural Shades . . . . .	12
Multiple Shades on One Headrail: Natural Shades . . . . .	13
Bay and Corner Windows . . . . .	14
Valance: Natural Shades, Deco-Trim Valance or Hems: Natural Shades, Valance: Natural Drapes . . . . .	15
Valance Returns for Standard Valances, Palisade Valance Only: Natural Shades & Natural Drapes . . . . .	16
Accent Gimp: Natural Shades . . . . .	17
Turned Headrail: Natural Shades, Direct Mount: Natural Shades . . . . .	18

### General Information

Stack Charts: Natural Shades, Natural Drapes, Natural Drapes 10% Standard Fullness, Natural Drapes 60% Fullness . . . . .	19
Bracket Chart: Natural Shades . . . . .	20
Continuous Loop Product Detail: Natural Shades . . . . .	21-23
Cordless Product Detail: Natural Shades . . . . .	24-25
Product Detail: Natural Drapes . . . . .	26
Warranty . . . . .	27

## PLEASE NOTE:

Photos and illustrations are for inspiration only.  
Not all product configurations are available in all countries.

Window blinds with a damaged or loose tension device or retractable cord that fails to fully retract pose a strangulation risk to children. To avoid this potential strangulation risk, consider purchasing cordless products or products with inaccessible cords.

## VEUILLEZ NOTER:

Les photos et les illustrations ne sont offertes qu'à titre d'inspiration.  
Toutes les configurations de produits ne sont pas disponibles dans tous les pays.

Les stores de fenêtre dont le dispositif de tension est endommagé ou lâche, ou dont le cordon rétractable ne se rétracte pas complètement, présentent un risque d'étranglement pour les enfants. Pour éviter cet éventuel risque d'étranglement, envisagez d'acheter des produits sans fil ou des produits dont les cordons sont inaccessibles.

## Features

### Natural Shades



Graber® Natural Shades are crafted from bamboo reed, slit bamboo, sisal, grass, and jute materials. They add natural color, texture, and dimension to your windows and create a comfortable atmosphere of casual elegance or simple sophistication.

- Standard Roman, Old Style Roman, or Looped Roman shade designs
- Wide selection of colors, textures, and unique weaves
- Cordless lift, continuous loop lift, and motorized lift available
- 6" (15.3 cm) valance with horizontally-oriented material is standard on shades except for motorized lift and continuous loop lift
- 9" (22.9 cm) valance with horizontally-oriented material is standard on shades with motorized lift and continuous loop lift
- Old Style inside mount shades will automatically come with back valances to conceal lift components

### Natural Drapes

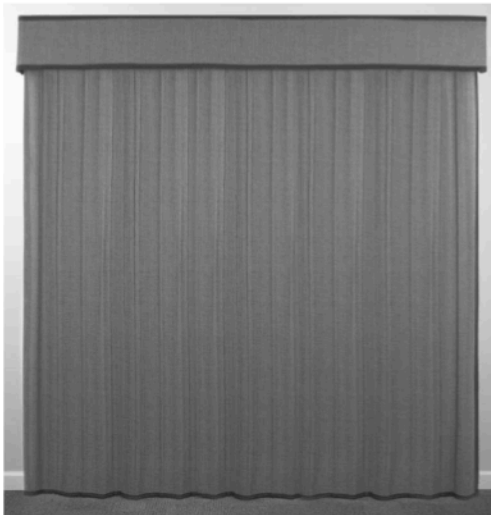

- Natural drapes feature the rolling qualities of drapery in vertically-oriented natural shade material
- Features wand control in single or split stack
- Choose from standard fullness (when closed, waves slightly) or a 60% fullness (when closed, features drapery-like appearance)
- Premiere valance with vertical material orientation included with drape
- Natural Drape without valance (optional, no additional charge) is not recommended, as aluminum headrail and hardware will be visible
- Wood or fabric cornice is an option in place of valance; see wood cornice product information guide
- Valance and returns will extend  $\frac{3}{8}$ " (1.0 cm) per side on inside mount, and  $\frac{1}{16}$ " (1.5 cm) to  $\frac{5}{16}$ " (1.6 cm) per side on outside mount, further than drape width
- Edge banding required on the drapes and valance
  - 1" (2.6 cm) solid edge banding for the drapes
  - Valance uses matching 1" (2.6 cm) edge banding on vertical orientation
  - Liner is required on valance

**NOTE:** Natural Drape not available with BeachFront, Cameron, Havana, Meilin, Purcell, Rowen, Satterra, Terrestrial, Ventura, or Zishan.

# Features

## The Beauty of Natural Shades

There is simply no substitute for the beauty of the materials used in natural shades. The colors and textures of bamboo, reeds, grass, and jute have a distinct character and one-of-a-kind look that synthetic materials can't match.

### Unique Characteristics of Natural Shades

#### Asymmetry

Materials used in natural shades are naturally grown and harvested. Variations in shape, thickness, texture, and grain are to be expected from Mother Nature. While adding personality, these variations create asymmetry in the weave that may alter the appearance of the finished shades. Specifically, you may notice:

- **Uneven Spacing or Gaps**—Differences in bamboo or reed shapes and thicknesses can create uneven spacing or gaps in the weave
- **Pattern Changes or Gaps**—The varying thickness of grassy materials, tied knots, and splices can create visual disruptions in the weave pattern or gaps in the weave
- **Length Differences**—Variations in thickness, bamboo joints, or reed sizes can create length differences from both sides of the shades
- **Bowing or Arching**—Different drying rates of bamboo fibers can create a bowing or arching effect on the finished shades

To minimize variations, all materials used are hand selected to comply with strict specifications. These variations are not considered flaws, but rather normal characteristics expected from naturally grown materials.

#### Color

Evolving with age, the color of bamboo, reeds, grasses, jute, and other natural materials will change slightly. Depending on material composition, they may lighten or darken due to direct sunlight or other climatic conditions. Uncolored or natural materials will experience the most color shift, changing from a green color at harvest to a yellow-brown color over three to six months. Color matching of shades cannot be guaranteed as these are natural reactions to aging.

With character, however, comes inherent natural properties that may influence the appearance of the finished shade. Recognizing and understanding the characteristic traits of natural materials provides more satisfaction and enjoyment once you know why each shade is truly unique!

#### Stretching/Sagging

The natural elasticity of yarns, combined with the weight of the woven material, may cause shades to stretch or sag from 1" (2.6 cm) to 1½" (3.9 cm), and sliding panels to stretch or sag from 1" (2.6 cm) to 2" (5.1 cm) after installation. This is particularly noticeable on inside mount shades or shades that extend from ceiling to floor. Ordering shades shorter than needed will help compensate for stretching over time.

#### Tips

During the shipping process, the natural material may have shifted slightly due to its woven construction, causing slight shortening or uneven edges.

**Height**—If after installation, the shades are slightly shorter than ordered, grasp the bottom of the shades and gently pull to stretch to the preferred height. Some materials will also stretch by themselves over time.

**Uneven Edges**—Lightly tap edge of the shades with a flat edge (for example, a ruler) until even.

**Frayed Edges**—If threads come loose near the edges, use sharp scissors to trim off stray threads.

#### Light Control and Privacy

**Sheer**—Allows the most amount of light into the room for a minimum amount of privacy and a view to the outside. Objects in the room can be seen quite clearly through shades.

**Light Filtering**—Allows light to gently filter through and provides privacy. Images and shapes may be seen through these shades.

Natural shades may have variations and visual inconsistencies in color, weave, grain, and texture. They may also crack or split, twist or bow, shrink or stretch, and change color over time due to aging, direct sunlight, or other climatic conditions. These unique characteristics are inherent in natural materials and are not considered defects in material or workmanship. Exact color matches cannot be guaranteed.

## Features

### Material Styles and Information: Natural Shades & Natural Drapes

Style Name	Color Name	Color Number	Maximum Fabric Width (inches) (cm)	Light Control and Privacy**	Material Content	Edge Banding Requirements (Complimentary when required)	Fabric Weight
Bayport	Sand Dune	23190	96 (243.9)	Sheer	Bamboo, Paper, Polyester	Optional	L
Beachfront*	Tidepool	60040	96 (243.9)	Sheer	Bamboo Reed	Optional	L
	Surf	60041					
	Thatch	60042					
Berwick	Sand Wood	43195	96 (243.9)	Sheer	Ramie	Optional	L
Bellamy	Camel	80821	96 (243.9)	Light Filtering	Bamboo Slat, Bamboo Reed, Jute	Optional	M
	Rustic Weave	80820					
Boardwalk	Light Fossil Gray	15961	96 (243.9)	Sheer to Light Filtering	Bamboo Reed, Grass, Jute	Optional	M
	Pier	15968					
	Saddlery	15962					
Brooklyn	Swan	15871	96 (243.9)	Light Filtering	Bamboo Slat, Bamboo Reed	Optional	H
	Weathered Beige	15870					
Cameron*	Cloud	65781	96 (243.9)	Sheer to Light Filtering	Paper	Optional	L
	Fairweather Blue	65782					
	Khaki Canvas	65783					
	Whole Wheat	65780					
Chencun	White	60417	96 (243.9)	Sheer to Light Filtering	Slit Bamboo, Bamboo Reed	Optional	M
	Appaloosa	00846					
Cherish	Natural Sparkle	53205	96 (243.9)	Sheer	Linen Yarn, Bamboo Stick, Boucle Yarn, Lurex Thread, Pes Thread	Optional	L
Denver	Flaxseed	55750	96 (243.9)	Light Filtering	Bamboo Slat, Bamboo Reed	Optional	H
	Foggy Blue Ridge	55752					
	Sweet Cream	55751					
Hadley	Ivory Elegance	35910	96 (243.9)	Sheer to Light Filtering	Bamboo Slat, Bamboo Reed, Metal Thread	Required	L
	Silver Mist	35911					
Inan	Umber	04858	96 (243.9)	Sheer to Light Filtering	Slit Bamboo, Bamboo Reed, Jute Rope	Optional	H
Interlude	Blue Ridge	83320	96 (243.9)	Sheer to Light Filtering	Flax, Jute	Optional	L
	Dusty Lilac	83321					
	Ivory Tusk	83322					
	Sand Cream	83323					
Kelton	Ivory	25891	96 (243.9)	Sheer	Bamboo Reed	Required	L
	Jet Black	25892					
	Soft Coal	25893					
	True White	25890					
Lipo	Earthtones	06793	96 (243.9)	Sheer to Light Filtering	Slit Bamboo, Bamboo Reed, Jute Rope	Optional	H
	Ambrosia	06702					
	Natural	60706					
Merino	Faded Star White	50510	96 (243.9)	Sheer to Light Filtering	Bamboo Reed, Jute, Jute Braid	Optional	M
	Grenada	55507					
	Stardust	50511					
Moniz	Finland	05080	96 (243.9)	Light Filtering	Bamboo Reed, Grass Rope	Optional	H
	Peru	05081					
	Austria	05083					
	Belgium	05084					
Olympia	Natural White	38345	96 (243.9)	Sheer	Linen Yarn, Bamboo Stick, Boucle Yarn, Poly Thread	Required	L
Oxford	Crisp Cotton	45742	96 (243.9)	Sheer to Light Filtering	Bamboo, Paper	Optional	L
	Ebony	45743					
	French Roast	45741					
	Tender Taupe	45740					

\*Not available in Natural Drapes

\*\*Privacy and light control without liner; addition of privacy or room-darkening liner improves privacy and light control. All liners have a similar streetside appearance.

\*\*\*See sliding panels cost and product reference guide for more information.

## Features

### Material Styles and Information: Natural Shades & Natural Drapes

Style Name	Color Name	Color Number	Maximum Fabric Width (inches) (cm)	Light Control and Privacy**	Material Content	Edge Banding Requirements (Complimentary when required)	Fabric Weight
Purcell*	Golden Grain Sunbleached Sand	40731 40730	96 (243.9)	Sheer to Light Filtering	Jute	Optional	L
Paralian	Mink Otter	25050 25052	96 (243.9)	Light Filtering	Bamboo, paper yarn	Required	L
Revelry	Blue Ridge Dusk Dove Alabaster Moss Muted Marine Tahoe Brown	81742 80743 80745 80746 80747 81748 80749	96 (243.9)	Sheer to Light Filtering	Bamboo reed	Optional	H
Reminisce	Faded Slate Faded Star White Fossil Gray	32360 32361 32363	96 (243.9)	Sheer to Light Filtering	Jute, bamboo	Optional	H
Rowen*	Thundercloud Toasted Tan	60770 60771	96 (243.9)	Sheer to Light Filtering	Jute	Optional	L
Saterra*	Azure Terrain Surf	03269 03370 03374	96 (243.9)	Sheer	Jute	Optional	L
Sarto	Burlap Fawn	75810 75800	96 (243.9)	Sheer to Light Filtering	Bamboo Reed, Yarn	Optional	M
Seasons	Blue Ridge Sedona Sands Faded Star White Sandpiper	33386 33389 33387 33388	96 (243.9)	Sheer	Bamboo	Optional	M
Selene	Oatmeal Sophisticated Slate Vanilla Cream	30900 30901 30902	96 (243.9)	Sheer to Light Filtering	Bamboo Reed, Paper	Optional	L
Serenity	Haze	11502	96 (243.9)	Light Filtering	Bamboo Reed	Optional	H
Stateside	Admiral Navy Faded Star White Fossil Gray Tiki	85832 85833 85831 85830	96 (243.9)	Light Filtering	Wood	Required	H
Tatum	Warm Wicker	70790	96 (243.9)	Sheer to Light Filtering	Bamboo Reed, Paper	Optional	L
Terrestrial*	Alpaca Camel	28001 28003	96 (243.9)	Light Filtering	Grass	Optional	L
Toushan II	Taupe	63659	96 (243.9)	Light Filtering	Slit Bamboo, Bamboo Reed	Optional	H
Ventura*	Cabin Fever Lake Blue Marshmallow	20881 20880 20883	96 (243.9)	Sheer	Bamboo Reed, Linen Yarn	Optional	L
Verity	Genteel Gray Suitcoat Warm Wicker	46460 46461 46462	96 (243.9)	Sheer to Light Filtering	Bamboo, Jute	Optional	L
Wild Haven	Faded Star White Light Fossil Gray Porch Swing Sandpiper	47465 47466 47467 47468	96 (243.9)	Sheer to Light Filtering	Bamboo, Jute	Optional	L
Zishan*	Stardust Hut	43731 30736	96 (243.9)	Light Filtering	Grass, Bamboo Reed	Optional	L

\*Not available in Natural Drapes

\*\*Privacy and light control without liner; addition of privacy or room-darkening liner improves privacy and light control. All liners have a similar streetside appearance.

\*\*\*See sliding panels cost and product reference guide for more information.

## Size Considerations

### Natural Shades

	Width		Height	
	Minimum (inches) (cm)	Maximum (inches) (cm)	Minimum (inches) (cm)	Maximum (inches) (cm)
Standard Roman Old Style Roman	10 (25.4) outside mount 10½ (26.7) inside mount	96 (243.9) single 144 (365.8) multiple	12 (30.5) 18 (45.8) with deco-pocket hem	120 (304.8)
Looped Roman	12 (30.5) outside mount 12½ (31.8) inside mount			
Continuous Loop Lift	24 (61.0) outside mount 24½ (62.3) inside mount			108 (274.4)
Cordless Lift	18 (45.8) outside mount 18½ (45.8) inside mount	Determined by square feet, see cordless size charts		
Multiple Shades on One Headrail	20½ (52.1) exact	144 (365.8)	12 (30.5)	See price charts
12 Volt Motorized Lift	18 (45.8) outside mount 18½ (47.0) inside mount	Determined by square feet; see motorization price list for more details.		
24 Volt Motorized Lift	22 (55.9) outside mount 22½ (57.2) inside mount			

### Depth Requirements for Inside Mount

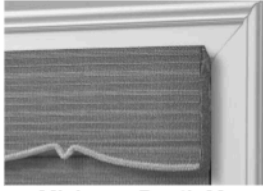
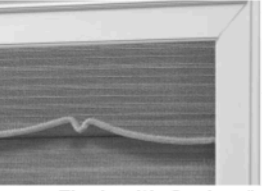
Type of Shade	Headrail Dimensions (inches) (cm)	 Partially recessed valance in window casing/molding		 Fully recessed valance in window casing/molding	
		Minimum Depth Mount (inches) (cm)	Flush with Casing (inches) (cm)		
Cordless Lift	1½ Headrail - ¾ x 1 ½ (1.9 x 3.9) Standard Headrail - 5/8 x 2¼ (1.6 x 5.8)	¾ (2.0)	1½ Headrail— 2¼" Standard Headrail— 3¼"		
Continuous Loop Lift Motorized Lift	¾ x 2¼ (1.6 x 5.8)		3¼ (8.1)		
Turned Headrail	1½ x ¾ (3.9 x 1.6)		1¾ (4.2)		



**NOTE:** With outside mount there will be a 1" gap between headrail and NY Bracket

### Natural Drapes

	Width		Height	
	Minimum (inches) (cm)	Maximum (inches) (cm)	Minimum (inches) (cm)	Maximum (inches) (cm)
Standard Drapery Fullness	16 (40.7) outside mount	192 (487.7)	20 (50.8)	96 (243.9)
60% Drapery Fullness	17 (43.2) inside mount			

**NOTE:** Minimum surface for outside mount: 3" (7.7 cm).

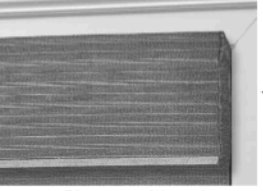
### Depth Requirements for Inside Mount

Headrail Dimensions (inches) (cm)		 Partially recessed valance in window casing/molding		 Fully recessed valance in window casing/molding	
		Minimum Depth Mount (inches) (cm)	Valance Flush with Casing (inches) (cm)		
Wand Control = ¾ x 1½ (2.3 x 3.9)	Standard drapery fullness	¾ (9.3)	8 (20.4)		
	60% drapery fullness	4½ (11.5)			

# Options

## Summary

The following is a list of options for natural shades. Most options are available in all styles and colors. Limitations will be based on fabric width and fabric type. See detailed descriptions on the following pages.

	Standard Roman	Old Style Roman	Looped Roman
Cordless Lift	•	•	
Continuous Loop Lift	•	•	•
Motorized Lift	•	•	
Angled Top	•		
Cut-Outs	•	•	
Multiple Shades on One Headrail	•	•	•

### No Charge Options: Natural Shades

- Direct mount (no installation mounting brackets)
- Side mount brackets available up to 42" wide
- Bay or corner window
- Hold down brackets<sup>†</sup>
- 2" Extension Brackets
- 2<sup>5</sup>/<sub>8</sub>" Extension Brackets
- 3<sup>1</sup>/<sub>2</sub>" Extension Brackets
- Extended New York Brackets
- Turned Headrail (non-operational only)
- 1.5" Headrail (cordless lift only)
- Valances
  - 6" (15.3 cm) standard
  - 9" (22.9 cm) standard (standard with continuous loop lift and motorized lift)
  - Back valance comes standard with Old Style inside mount shades (all control types)
  - No valance (always optional)

### Surcharge Options: Natural Shades

- Control types
  - Cordless lift
  - Motorized lift
  - Continuous Loop Lift
- Multiple shades on one headrail
- Specialty Shapes
  - Angled-Top
- Cut-outs
- Liners
- Edge banding\*
- Wood cornices/valances
- Valances
  - 9" (22.9 cm) standard
  - 6" (15.3 cm) premiere
    - Horizontally- or vertically-oriented
  - 9" (22.9 cm) premiere
    - Horizontally- or vertically-oriented
  - 9" (22.9 cm) deco-trim valance
- Only available hem is standard. Deco-trim hems are available for valances only.

### No Charge Options: Natural Drapes

- Control types
  - Wand control
- Ceiling mount brackets
- Edge banding\*
- Valances
  - 6" (15.3 cm) premiere (standard with natural drapes)
    - Horizontally- or vertically-oriented
  - 9" (22.9 cm) premiere
    - Horizontally- or vertically-oriented
  - No valance (always optional)
- Fullness: standard (slight wave when closed)

### Surcharge Options: Natural Drapes

- Fullness: 60% (drapery-like appearance when closed)
- Liners
- Wood cornices/valances

\*Edge banding: Optional on shades or valances on most fabrics with horizontally-oriented material; required on valances with vertically-oriented material and designated fabrics that fray easily.

<sup>†</sup>Hold down brackets: Only available at time of order. Cannot be retrofitted. Not available with edge banding, deco-trim, or deco-pocket hem.

# Options

## Continuous Loop Lift: Natural Shades



Cord Shown

- For surcharge, see options pricing
- Available on Standard Roman, Old Style Roman, and Looped Roman shades
- Continuous Loop lift control raises and lowers the shade and is color coordinated to the shade material
  - Shades under 30 square feet (2.8 square meters) have color coordinated cord
  - Shades over 30 square feet (2.8 square meters) will use a nickel-plated steel bead chain loop in place of cord
  - When ordering different size shades for the same room, specify if bead chain is preferred for all shades
- Allows for easier operation of larger shades
- 9" (22.9 cm) valance is standard with the continuous loop lift option; (6" (15.3 cm) valance not available)
- Old Style inside mount shades will automatically come with back valances to conceal lift components
- Available in the US only

### Continuous Cord Loop Lengths

Finished Blind Height	Cord Loop/ Beaded Chain Loop Length (inches)	Cord Loop/ Beaded Chain Cut Length (inches)
Up to 36"	18	36
36 <sup>1</sup> / <sub>16</sub> " - 48"	24	48
48 <sup>1</sup> / <sub>16</sub> " - 64"	36	72
64 <sup>1</sup> / <sub>16</sub> " - 80"	48	96
80 <sup>1</sup> / <sub>16</sub> " - 96"	60	120
96 <sup>1</sup> / <sub>16</sub> " or greater	72	144

# Options

## Cordless Lift: Natural Shades



- For surcharge and size restrictions, see price charts
- Available on Standard Roman and Old Style Roman
- Cordless lift shades offer a safer alternative for homes with children and pets
- Easy to use: to lower shade, pull down on metal ring; to raise shade, gently pull metal ring and guide shade to desired location
- Not available with cut-outs or angled-top. Deco-trim and deco-pocket hems are no longer offered on any control type; deco-trim is only available on valances
- 6" valance is standard with Standard Roman shades
- 1.5" headrail available with select sizes and fabrics
- Old Style inside mount shades will automatically come with back valances to conceal lift components
- Available in the US only

Standard Headrail Depth		No Liner		Privacy Liner		Room-Darkening Liner	
		Width		Width		Width	
		w < 30"	30" ≤ w ≤ 96"	w < 30"	30" ≤ w ≤ 96"	w < 30"	30" ≤ w ≤ 96"
Fabric Group	Light	Length ≤ 85"	SQFT ≤ 58	Length ≤ 80"	SQFT ≤ 52	Length ≤ 78"	SQFT ≤ 50
	Medium	Length ≤ 82"	SQFT ≤ 48	Length ≤ 78"	SQFT ≤ 44.5	Length ≤ 75"	SQFT ≤ 44
	Heavy	Length ≤ 70"	SQFT ≤ 33.3	Length ≤ 64"	SQFT ≤ 29	Length ≤ 64"	SQFT ≤ 28

*\*Note fabric is not supplied for lengths greater than 86"*

1-1/2" Headrail Depth		No Liner		Privacy Liner		Room-Darkening Liner	
		w < 25"	25" ≤ w ≤ 96"	w < 25"	25" ≤ w ≤ 96"	w < 25"	25" ≤ w ≤ 96"
Fabric Group	Light	w < 25"	25" ≤ w ≤ 96"	w < 25"	25" ≤ w ≤ 96"	w < 25"	25" ≤ w ≤ 96"
		Length ≤ 70"	SQFT ≤ 27.8	Length ≤ 68"	SQFT ≤ 27	Length ≤ 68"	SQFT ≤ 26
	Medium	w < 25"	25" ≤ w ≤ 96"	w < 25"	25" ≤ w ≤ 96"	w < 40"	40" ≤ w ≤ 96"
		Length ≤ 68"	SQFT ≤ 26	Length ≤ 65"	SQFT ≤ 25	Length ≤ 65"	SQFT ≤ 21.5
	Heavy	w < 40"	40" ≤ w ≤ 96"	w < 40"	40" ≤ w ≤ 96"	w < 50"	50" ≤ w ≤ 96"
		Length ≤ 64"	SQFT ≤ 20	Length ≤ 62"	SQFT ≤ 18.1	Length ≤ 62"	SQFT ≤ 18.1

*\*Note fabric is not supplied for lengths greater than 86"*

## Motorized Lift: Natural Shades

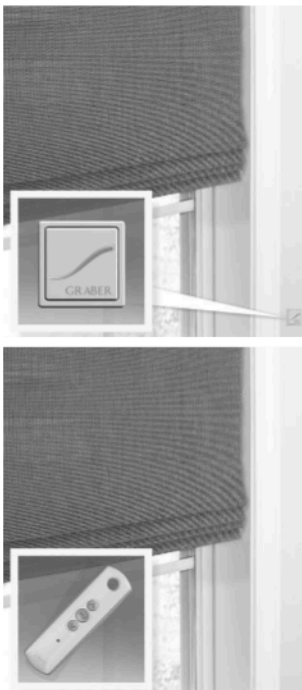

Refer to motorization price list for additional options, sizing, and pricing.

### Features

- Window treatments can be operated from virtually anywhere in the home
- Provides easy operation of hard-to-reach or large window coverings
- Efficiently manages energy (heat gain and loss)
- Operate multiple window treatments simultaneously or individually
- A safer alternative to traditional cords used to operate window coverings; ideal for homes with children and pets
- Easily integrated with home automation systems
- Low-voltage motorization requires no costly electrical hard-wiring
- Old Style inside mount shades will automatically come with back valances to conceal lift components

# Options

## Control Options: Natural Drapes



### Wand Control: No Charge—Default Control Type

- Ivory fiberglass wand positioned behind drape
- Stack right, left, or split
- Split stack will have 2 wands

Finished Blind Length (inches) (cm)	Wand Length (inches) (cm)
Up to 30 (76.2)	12 (30.5)
30 <sup>1</sup> / <sub>16</sub> to 48 (76.4 to 122.0)	24 (61.0)
48 <sup>1</sup> / <sub>16</sub> to 77 (122.1 to 195.6)	36 (91.5)
77 <sup>1</sup> / <sub>16</sub> to 92 (195.8 to 233.7)	48 (122.0)
92 <sup>1</sup> / <sub>16</sub> to 96 (233.9 to 243.9)	60 (152.4)

## Fullness: Natural Drapes

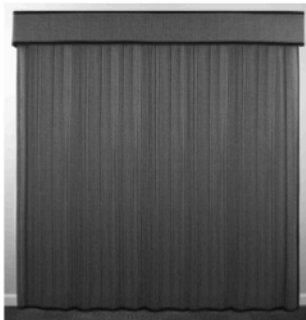

Standard Fullness Right Stack

### For surcharges, see options pricing

- Standard fullness (when closed, waves slightly)
- 60% fullness (when closed, features drapery-like appearance)
- Premiere valance included at time of order; see valance options for available styles



60% Fullness Right Stack

# Options

## Liners: Natural Shades & Natural Drapes



### For surcharges, see options pricing

- Liners are 100% polyester
- Available up to 96" (243.9 cm) wide on shades and 192" (487.7 cm) on drapes
- Privacy and room-darkening liner colors available
- All liners are neutral to the street
- Liner reversal available upon request

### Privacy Liner

A privacy liner is a good choice for dining rooms, living rooms, and other semi-private areas, subduing the light that enters a room. Objects appear as silhouettes from the outside. Small pinholes of light may be visible through shades with privacy liners due to the attached cord rings; see room-darkening liners for enhanced light control.

### Room-Darkening Liner

This liner blocks most incoming light and provides complete privacy. Ideal for bedrooms and media rooms.

Colors	Privacy Color Number	Room-Darkening Color Number
Cocoa	2297	6297
Taupe	2659	6659
Sand	2701	6701
Seal	2012	6012
Snow White	2909	6909

## Edge Banding and Colors: Natural Shades & Natural Drapes

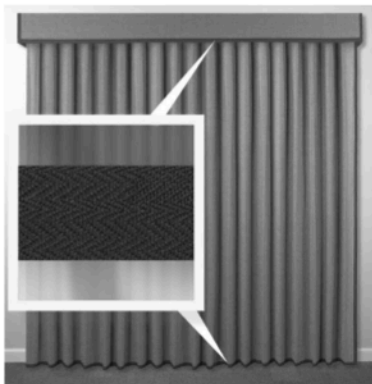
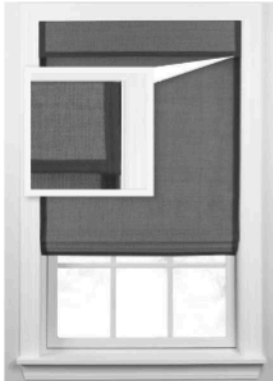

### For surcharge, see options pricing

- Edge banding adds a framed colour accent and can also eliminate material fray on edge of shade. Required on Paralian, Hadley, Kelton, and Stateside.
- 1" (2.6 cm) fabric banding is applied to sides and bottom of shade and valance
- Deco-trim valance may be ordered with edge banded shades; however, the deco-trim valance will be edged with decorative gimp
- See chart for colors
- Edge Banding not available on deco-trim, angled-top shades, cut-outs, or with hold down brackets

### Woven Wood Drapes

- 1" (2.6 cm) solid colors available on top and bottom of drapes: **no charge**
- Optional 1" (2.6 cm) solid colors available on drape sides: **no charge**
- Lined drapes require edge banding on all four sides
- 1" (2.6 cm) edge banding of same color will be on top and bottom edge of valance
- Use chart below for colors

Edge Banding	1" (2.6 cm) Color Number	Natural Shades	Natural Drapes
Black	7000	•	•
Chocolate	7006	•	•
Cocoa	7001	•	•
Dark Beige	7005	•	•
Gray	7176	•	•
Light Sage	7173	•	•
Mink Gray	7174	•	•
Muslin	7172	•	•
Smoke	7175	•	•
Snow White	7170	•	•
Taupe	7008	•	•
Toffee	7002	•	•
Vanilla	7171	•	•

# Options

## Cut-Outs: Natural Shades

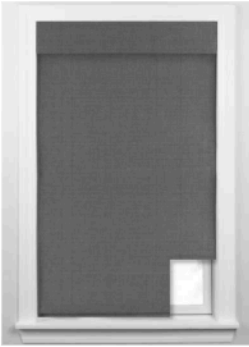

For surcharge, see options pricing

- Available with Standard and Old Style Roman shades
- Bottom corner cut-out (diagram A):
  - Maximum width: 6" (15.3 cm) cut-out
  - Any height (up to the headrail)
- Bottom center cut-out (diagram B):
  - Maximum height: 5" (12.7 cm) cut-out
  - Maximum width must leave 3" (7.7 cm) on each side of the cut-out
- Not available with: hold-down brackets, edge banding, deco-trim hems, deco-pocket hems, cordless lift, continuous loop lift, or Looped Roman shades

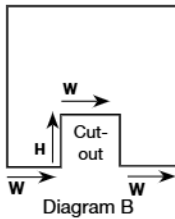
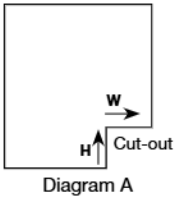

## Non-Operational Angled-Top: Natural Shades



For surcharges, see options pricing

- 3-day manufacturing time does not apply
- For angled-top shades, supply all four measurements (A, B, C, D) as shown in the diagram below
- 6" (15.3 cm) and 9" (22.9 cm) standard valance only
- Valance requires gimp trim at the top edge by the headrail (A)
- Valance returns are not available
- Available as non-operational only
- Available as Standard Roman only

Minimum Width	18" (45.8 cm) (outside mount) 18½" (47.0 cm) (inside mount)
Maximum Straight Width	60" (152.4 cm) (outside mount) 60½" (153.7 cm) (inside mount)
Minimum Height	12" (30.5 cm)
Minimum Height (short side)	7½" (19.1 cm)
Maximum Height	86" (218.44 cm)
Maximum Degree of Angle	60°

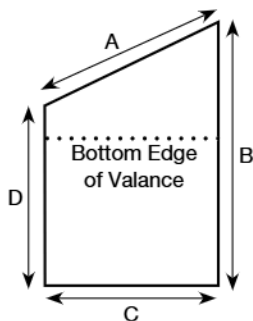

### Measuring Outside Mount:

1. Measure exact width and height of area to be covered. It is recommended that shades overlap window frame or opening by ½" (3.9 cm) on each side.
2. Measure height of opening on left side and mark this dimension "left". Allow for overlap as desired: ½" (3.9 cm) on top and bottom is recommended.
3. Measure height of opening on the right side and mark this dimension "right". Allow for same overlap as left side.
4. Factory will determine the angle from these three dimensions.

# Options

## Multiple Shades on One Headrail: Natural Shades

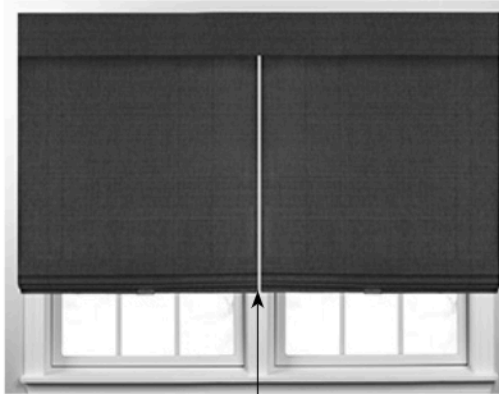

1/2" (1.3 cm) Gap

For surcharges, see options pricing

### How to Measure

1. Measure overall width of area to be covered.
2. Measure width of the area each shade is to cover; measure and specify left shade first, continuing to the right.  
**NOTE:** Minimum of 1/2" (1.3 cm) between shades for operating clearance.
3. Total width of all shades, plus clearance (gap), must equal the overall headrail width.
4. Use standard inside or outside measuring directions for height.
5. For patio doors, measure height to within 1" (2.6 cm) of the floor either from the ceiling or a point high enough above door to provide clearance; cords should be on outside edges of shades; outside mount (wall) installation is recommended for patio doors.

- Horizontal and vertical patterns will not align across shades
- Shades operate separately
- Controls can be on the right or left at no charge
  - Standard for two-on-one headrail: left panel—left control; right panel—right control
- Cordless and motorized lift
  - Two-on-one and three-on-one available
- Continuous loop cord lift
  - Two-on-one available with control positions to the outside
  - Three-on-one available if the lift control is combined on two shades (control positions must be to the outside)
  - Three-on-one available if the lift control is on combined on all three shades; horizontal material alignment between panels is not guaranteed
- Liner options available
- Edge banding is available—will be attached around each panel
- Shades up to the maximum material width will have a continuous valance
- Shades over maximum material width will have a valance with each panel which are butted in between each panel gap
- Premiere valance will not be spliced at the same dimensions as the multiple blinds; premiere valances will be spliced evenly

**NOTE:** Horizontally-oriented valances over 96" (243.9 cm) will be spliced in one to three places and will not align with shade panels. Vertically-oriented material will be one continuous piece. Hardwood frame will be spliced at 94" (238.8 cm) with returns and 95" (241.3 cm) without returns.

# Options

## Bay and Corner Windows

- Available on Standard Roman and Old Style Roman shades
- Bay and corner shades are used to butt two shades together in a corner window
- Depending on the angle, some corner shades cannot be raised to the same height
- Bay and corner shades not available with hold-down brackets, Looped Roman shades, and multiple shades on one headrail
- Horizontal and vertical pattern alignment between shades cannot be guaranteed
- Priced as standard shades, no additional surcharge
- Headrails will not be mitered
- Standard valances will not be mitered
- Premiere valances will be mitered

**NOTE:** Manufacturer will take appropriate deduction for corner/bay windows. If deductions are not required, do not order as corner/bay.

### Measuring Information

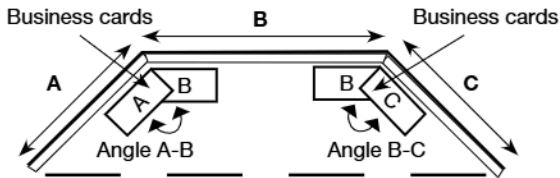
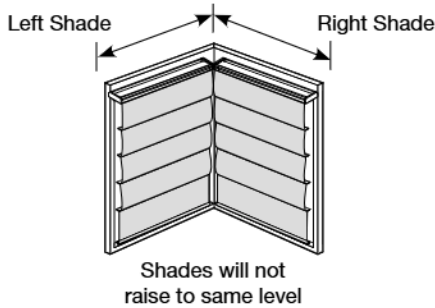

### Corner Window

Measure:

Width of each window from corner to the point you would like to cover.

### Three-Sided Bay Window

Measure:

A & C: Width of side windows from the corners to the point you would like the blind to cover.

B: Width of the center window from corner to corner.

Angle A-B: Angle between windows (A) and (B).

Angle B-C: Angle between windows (B) and (C).

Measure bay angle using protractor or angle finder, or use two business cards in bay corner as illustrated and fax to customer service.

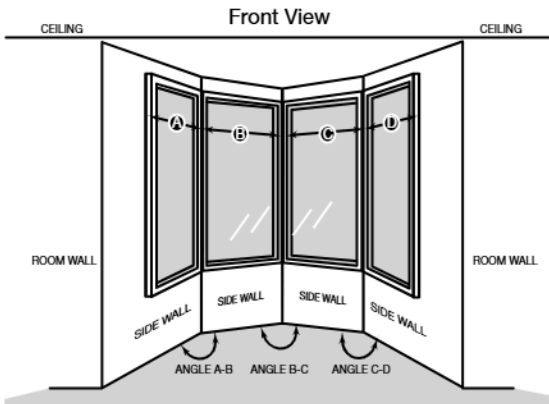

### Four-Sided Bay Window

Measure:

A & D: Width of side windows from the corners to the point you would like the blind to cover.

B & C: Width of each window from corner to corner.

Angle A-B: Angle between windows (A) and (B).

Angle B-C: Angle between windows (B) and (C).

Angle C-D: Angle between windows (C) and (D).

Measure bay angle using protractor or angle finder, or use two business cards in bay corner as illustrated and fax to customer service.

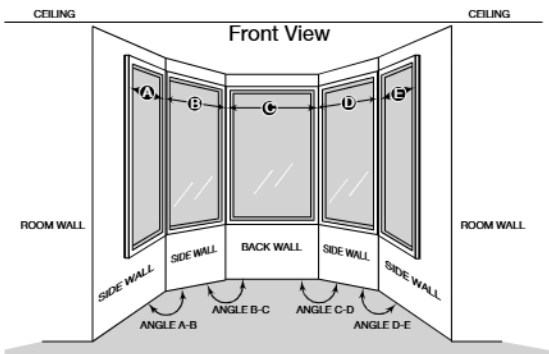

### Five-Sided Bay Window

Measure:

A & E: Width of side windows from the corners to the point you would like the blind to cover.

B, C & D: Width of each center window from corner to corner.

Angle A-B: Angle between windows (A) and (B).

Angle B-C: Angle between windows (B) and (C).

Angle C-D: Angle between windows (C) and (D).

Angle D-E: Angle between windows (D) and (E).

Measure bay angle using protractor or angle finder, or use two business cards as illustrated and fax to customer service.

# Options

## Valance: Natural Shades

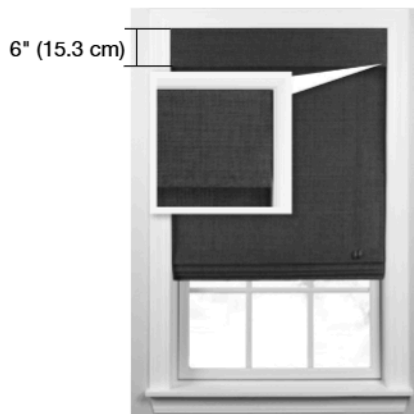

6" (15.3 cm)

Standard Valance Horizontal Orientation



Premiere Valance Option B Shown

### Cordless no charge options

- 6" (15.3 cm) valance with shade
- Old Style inside mount shades will automatically come with back valances to conceal lift components
- No valance is optional; unfinished headrail and hardware are visible

### Continuous Loop Lift and motorized lift no charge options

- 9" (22.9 cm) valance with shade (6" (15.3 cm) valance is not available)
- Old Style inside mount shades will automatically come with back valances to conceal lift components

### Additional valance information

- Edge banding will be applied to the sides and bottom of the valance if option is chosen for complete finished shades
- Liner can be added to the valance; must specify privacy or room-darkening liner and color; see price chart for surcharge
- No valance is also an option; however, unfinished headrail and hardware will be visible.

Control Type/ Shade Options with Standard Valance	Full Recess Depth Including Valance (inches) (cm)	Standard Return Width Outside Mount (inches) (cm)	Standard Return Width Inside Mount (inches) (cm)	Minimum Return Width (inches) (cm)	Maximum Return Width (inches) (cm)
Continuous Loop Lift	3 <sup>3</sup> / <sub>16</sub> (8.1)	2 <sup>13</sup> / <sub>16</sub> (7.2)	2 <sup>1</sup> / <sub>4</sub> (5.8)	1 <sup>1</sup> / <sub>2</sub> (3.9)	3 <sup>1</sup> / <sub>2</sub> (8.9)
Motorized Lift*	3 <sup>3</sup> / <sub>16</sub> (8.1)	2 <sup>13</sup> / <sub>16</sub> (7.2)	2 <sup>1</sup> / <sub>4</sub> (5.8)	1 <sup>1</sup> / <sub>2</sub> (3.9)	3 <sup>1</sup> / <sub>2</sub> (8.9)
Cordless Lift	3 <sup>3</sup> / <sub>16</sub> (8.1)	2 <sup>13</sup> / <sub>16</sub> (7.2)	2 <sup>1</sup> / <sub>4</sub> (5.8)	1 <sup>1</sup> / <sub>2</sub> (3.9)	3 <sup>1</sup> / <sub>2</sub> (8.9)

\*See motorized product information guide for more details.

- No liner or edge banding on valance returns

## Valance: Natural Drapes

- No charge for premiere valance at time of order (must select option)
- Liner required on Natural Drape valance
- No valance is optional; aluminum headrail and hardware are visible
- Valance return height will match valance height option chosen

## Deco-Trim Valance: Natural Shades

### Seascape



This design is scaled to the width of the shade

### Dentil



This design will repeat with the width of the shade

### Cathedral



This design will repeat with the width of the shade

### Horizon



This design is scaled to the width of the shade

### For surcharge, see options pricing

- Distinctive valance with accent gimp
- Deco-trim valance is cut into the valance of the shade to a depth of approximately 2<sup>1</sup>/<sub>2</sub>" (6.4 cm)
- 9" (22.9 cm) deco-trim valance is measured from the top of the headrail to the lowest point
- Accent gimp must be selected with deco-trim valance
- Available with 9" (22.9 cm) valance only

# Options

## Valance Returns for Standard Valances

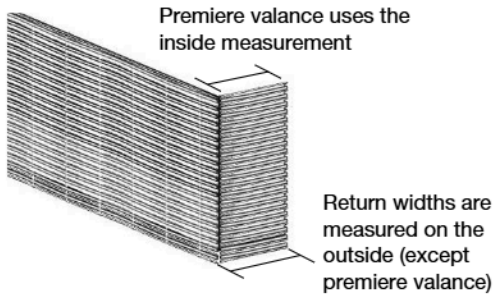

Window depths vary considerably depending on the age and style of the window. **Always** measure the window depth, regardless of the type of window treatment the client is considering. Knowing the depth when the order is placed can help prevent costly errors.

To calculate the return width, use this formula:

$$[\text{Standard return width}] \text{ minus } [\text{client window depth}] = \text{special return width to order for inside mount blind}$$

## Premiere Valance Only: Natural Shades & Natural Drapes

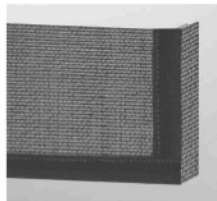

Option A

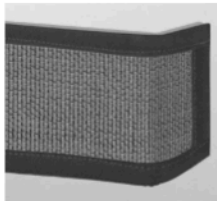

Option B

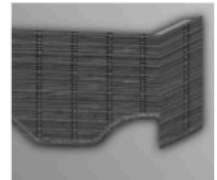

Option C

### Premiere valance only

- No charge option for natural drape at time of order

Natural material is mounted to a North American hardwood frame with mitered corner returns that attach separately. Valance upgrade options provide stable returns and a clean, uniform appearance.

- Valance can be ordered for use alone or to complement other window treatments
- Valance material is attached to a hardwood frame; includes valance clips to mount valance
- Valance returns are available (must be specified at the time of the order)
- Valance returns are standard on outside mount natural premiere valance based on headrail depth

Control Type/ Shade Options with Premiere Valance	Full Recess Depth Including Valance (inches) (cm)	Minimum Return Width (inches) (cm)	Return Width Inside/ Outside Mount— Standard Mounting Brackets (inches) (cm)	Return Width Inside/ Outside Mount— 2" (5.1 cm) Extension Brackets (inches) (cm)	Return Width Inside/ Outside Mount— 2 5/8" (6.7 cm) Extension Brackets (inches) (cm)	Return Width Inside/ Outside Mount— 3 1/2" (8.9 cm) Extension Brackets (inches) (cm)
Continuous Loop Lift	3 3/8 (8.1)	1 1/2 (3.9)	3 3/8 (9.1)	4 1/2 (11.5)	5 1/8 (13.1)	6 (15.3)
Motorized Lift*	3 3/8 (8.1)	1 1/2 (3.9)	3 3/8 (9.1)	4 1/2 (11.5)	5 1/8 (13.1)	6 (15.3)
Cordless Lift	3 3/8 (8.1)	1 1/2 (3.9)	3 3/8 (9.1)	4 1/2 (11.5)	5 1/8 (13.1)	6 (15.3)
Drape	8 (20.4)	2 (5.1)	6 1/2 (16.6)	N/A	N/A	N/A

\*See motorized product information guide for more details.

- Valances over maximum material width will be butted
- Edge banding is available on 6" (15.3 cm) or 9" (22.9 cm) horizontally- or vertically-oriented material; not available on deco-trim
- No liner or edge banding on valance returns

### Options:

- 6" (15.3 cm) or 9" (22.9 cm) valance with horizontal material orientation; edge banding is optional. 6" (15.3 cm) valance not available with motorized or continuous loop lift.
- 6" (15.3 cm) or 9" (22.9 cm) valance with vertical material orientation; 1" (2.6 cm) edge banding top and bottom mandatory (6" (15.3 cm) not available with motorized lift and continuous loop lift).
- 9" (22.9 cm) deco-trim valance; no vertical orientation option (must select accent gimp).
- Wood cornice: See cornices and valances price list.

**NOTE:** Horizontally-oriented valances over 96" (243.9 cm) will be spliced in one to three places and will not align with shade panels. Vertically-oriented material will be one continuous piece. Hardwood frame will be spliced at 94" (238.8 cm) with returns and 95" (241.3 cm) without returns.

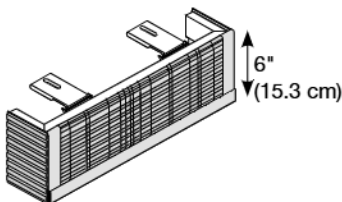

Valance less than 96" (243.9 cm)

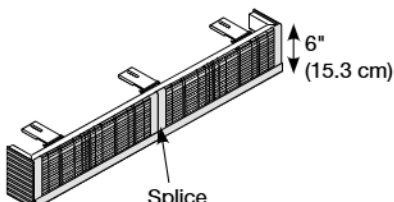

Valance over 96" (243.9 cm)

# Options

## Accent Gimp: Natural Shades

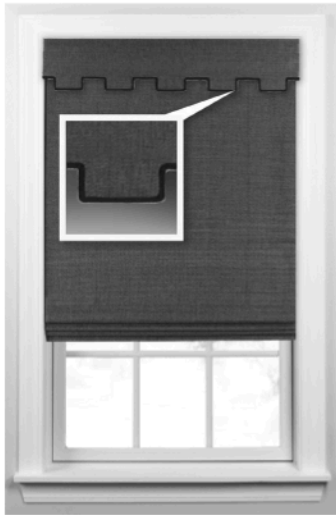

**For surcharges, see price charts**

- Required with 9" (22.9 cm) deco-trim valance. Optional on other horizontal material orientation valances and standard hems
- Not available with vertically-oriented material



**NOTE:** Must choose accent gimp color when a deco-trim style has been selected for the valance or hem.

Black . . . . .	156	Rock Gray . . . . .	399
Chocolate . . . . .	04	Tender Taupe . . . . .	103
Cream . . . . .	715	Toffee . . . . .	296
Dark Beige . . . . .	350	White . . . . .	417

## Options

### Turned Headrail: Natural Shades

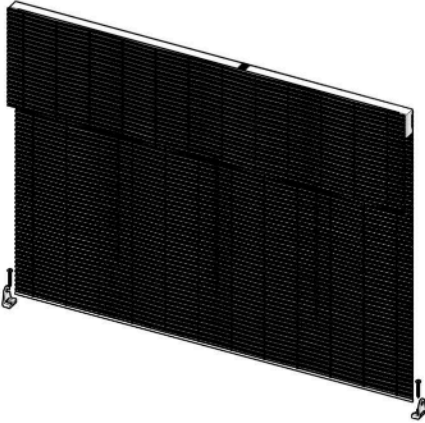

- **No charge**
- Headrail turned 90 degrees to allow for a smaller inside mount shade or for use on French doors
- Available as inside or outside mount; headrail mounted by placing mounting screws through headrail directly into mounting surface
- Minimum depth required: ¾" (2.0 cm)
- Available as Standard and Old Style Roman with no lift
- 6" (15.3 cm) comes standard. 9" (22.9 cm) standard and deco-trim valances are available for a surcharge
- Available as non-operational only
- **Valance returns are not available**

### Direct Mount: Natural Shades

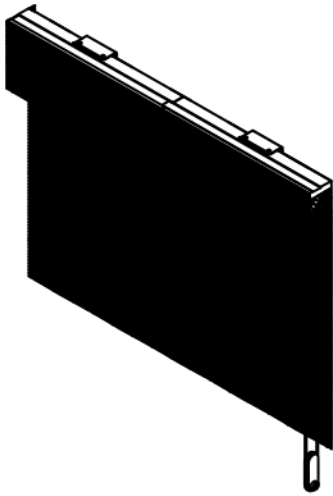

- **No charge**
- Option to remove metal mounting plates on shades with a wood headrail and mount directly to mounting surface
- Shade will come factory predrilled mounting holes in the wood headrail
- Available as inside or outside mount, headrail mounted by placing mounting screws through the headrail directly into the mounting surface.
- Minimum depth required: ¾" (2.0 cm)
- Available on motorized lift, continuous cord loop, angled-top, bay and corner windows
- Available in Standard Roman, Old Style Roman, and Looped shade styles.
- Available with all valance and return options
- 6" (15.3 cm) comes standard. 9" (22.9 cm) standard and deco-trim valances are available for a surcharge
- Returns are available

# General Information

## Stack Charts: Natural Shades

**NOTE:** For shades, stack height is measured from the top of the headrail to the lowest point of the shades when completely raised. Stack heights are approximate and will vary by material.

### Stack Height: Natural Shades

	Height of Shade up to (inches) (cm)	Standard Hem	
		No Liner (inches) (cm)	Privacy or Room-Darkening Liner (inches) (cm)
Continuous Loop Lift Motorized Lift • Standard Roman • Old Style Roman	30 (76.2)	9¾-10 (24.8-25.4)	9¾-10¼ (24.8-26.1)
	50 (127.0)	10¼-10¾ (26.1-27.4)	10½-11 (26.7-28.0)
	70 (177.8)	11-11¼ (28.0-28.6)	11¼-11½ (28.6-29.3)
	90 (228.6)	11½-11¾ (29.3-29.9)	11¾-12 (29.9-30.5)
	110 (279.4)	12-12¼ (30.5-31.2)	12¼-12½ (31.2-31.8)
	120 (304.8)	12½-12¾ (31.8-32.4)	12¾-13 (32.4-33.1)
Continuous Loop Lift • Looped Roman	30 (76.2)	10¾-11 (27.4-28.0)	10¾-11¼ (27.4-28.6)
	50 (127.0)	11¼-12¼ (28.6-31.2)	11½-13¼ (29.3-33.7)
	70 (177.8)	12½-13¾ (31.8-35.0)	13½-14¼ (34.3-36.2)
	90 (228.6)	14-14½ (35.6-36.9)	14½-15¼ (36.9-38.8)
	110 (279.4)	14¾-15¼ (37.5-38.8)	15½-16¼ (39.4-41.3)
	120 (304.8)	15½-15¾ (39.4-40.1)	16½-16¾ (42.0-42.6)
Cordless Lift • Standard Roman • Old Style Roman	30 (76.2)	8¾-9¼ (22.3-24.8)	8¾-10 (22.3-25.4)
	50 (127.0)	10¼-10½ (26.1-26.7)	10¼-10½ (26.1-26.7)
	70 (177.8)	10¾-11 (27.4-28.0)	10¾-11¼ (27.4-28.6)
	90 (228.6)	11¼-11½ (28.6-29.3)	11½-11¾ (29.3-29.9)
	110 (279.4)	11¾-12 (29.9-30.5)	12-12¼ (30.5-31.2)
	120 (304.8)	12-12½ (30.5-31.8)	12¼-12½ (31.2-31.8)

## Stack Charts: Natural Drapes

**NOTE:** For drapes, stack width is measured from the outside of the drapes to the inside of the drapes. Stack widths are approximate and will vary by material.

### Natural Drapes 10% Standard Fullness Stack Chart











Width of Shade up to (inches) (cm)	Wand Control			
	Single Stack		Split Stack, Each Side	
	Minimum Range Thinner Fabrics (inches) (cm)	Minimum Range Thicker Fabrics (inches) (cm)	Minimum Range Thinner Fabrics (inches) (cm)	Minimum Range Thicker Fabrics (inches) (cm)
27 (68.6)	6½-9 (16.6-22.9)	9-12 (22.9-30.5)	5½-7½ (14.0-19.1)	7½-9½ (19.1-24.2)
40 (101.6)	9-11 (22.9-28.0)	12-15 (30.5-38.1)	7½-9 (19.1-22.9)	9½-11½ (24.2-29.3)
51 (129.6)	11-14 (28.0-35.6)	15-18 (38.1-45.8)	9-10½ (22.9-26.7)	11½-13½ (29.3-34.3)
63 (160.1)	14-16 (35.6-40.7)	18-21 (45.8-53.4)	10½-12 (26.7-30.5)	13½-15 (34.3-38.1)
75 (190.5)	16-18 (40.7-45.8)	21-24 (53.4-61.0)	12-13½ (30.5-34.3)	15-16½ (38.1-42.0)
88 (223.6)	18-20 (45.8-50.8)	24-27 (61.0-68.6)	13½-14½ (34.3-36.9)	16½-18 (42.0-45.8)
102 (259.1)	20-22 (50.8-55.9)	27-30 (68.6-76.2)	14½-15 (36.9-38.1)	18-19½ (45.8-49.6)
115 (292.1)	22-24 (55.9-61.0)	30-33 (76.2-83.9)	15½-16½ (39.4-42.0)	19½-21 (49.6-53.4)
128 (325.2)	24-26 (61.0-66.1)	33-36 (83.9-91.5)	16½-18 (42.0-45.8)	21-22½ (53.4-57.2)
141 (358.2)	26-28 (66.1-71.2)	36-39 (91.5-99.1)	18-19 (45.8-48.3)	22½-24 (57.2-61.0)
157 (398.8)	28-30 (71.2-76.2)	39-43 (99.1-109.3)	19-21 (48.3-53.4)	24-25 (61.0-63.5)
170 (431.8)	30-32 (76.2-81.3)	43-46 (109.3-116.9)	21-22 (53.4-55.9)	25-26 (63.5-66.1)
183 (464.9)	32-35 (81.3-88.9)	46-49 (116.9-124.5)	22-23 (55.9-58.5)	26-27 (66.1-68.6)
192 (487.7)	35-37 (88.9-94.0)	49-53 (124.5-134.7)	23-24 (58.5-61.0)	27-28 (68.6-71.2)

### Natural Drapes 60% Fullness Stack Chart

Width of Shade up to (inches) (cm)	Wand Control			
	Single Stack		Split Stack, Each Side	
	Minimum Range Thinner Fabrics (inches) (cm)	Minimum Range Thicker Fabrics (inches) (cm)	Minimum Range Thinner Fabrics (inches) (cm)	Minimum Range Thicker Fabrics (inches) (cm)
27 (68.6)	8-12 (20.4-30.5)	11-16 (28.0-40.7)	7-9 (17.8-22.9)	9-12 (22.9-30.5)
40 (101.6)	12-15 (30.5-38.1)	16-21 (40.7-53.4)	9-11 (22.9-28.0)	12-14 (30.5-35.6)
51 (129.6)	15-18 (38.1-45.8)	21-25 (53.4-63.5)	11-13 (28.0-33.1)	14-16 (35.6-40.7)
63 (160.1)	18-21 (45.8-53.4)	25-30 (63.5-76.2)	13-15 (33.1-38.1)	16-18 (40.7-45.8)
75 (190.5)	21-24 (53.4-61.0)	30-35 (76.2-88.9)	15-17 (38.1-43.2)	18-20 (45.8-50.8)
88 (223.6)	24-27 (61.0-68.6)	35-40 (88.9-101.6)	17-19 (43.2-48.3)	20-22 (50.8-55.9)
102 (259.1)	27-30 (68.6-76.2)	40-44 (101.6-111.8)	19-21 (48.3-53.4)	22-25 (55.9-63.5)
115 (292.1)	30-34 (76.2-86.4)	44-49 (111.8-124.5)	21-23 (53.4-58.5)	25-28 (63.5-71.2)
128 (325.2)	34-38 (86.4-96.6)	49-54 (124.5-96.6)	23-25 (58.5-63.5)	28-30 (71.2-76.2)
141 (358.2)	38-42 (96.6-106.7)	54-60 (137.2-152.4)	25-27 (63.5-68.6)	30-32 (76.2-81.3)
157 (398.8)	42-46 (106.7-116.9)	60-66 (152.4-167.7)	27-29 (68.6-73.7)	32-36 (81.3-91.5)
170 (431.8)	46-49 (116.9-124.5)	66-71 (167.7-180.4)	29-31 (73.7-78.8)	36-38 (91.5-96.6)
183 (464.9)	49-52 (124.5-132.1)	71-75 (180.4-190.5)	31-33 (78.8-83.9)	38-40 (96.6-101.6)
192 (487.7)	52-55 (132.1-139.7)	75-80 (190.5-203.2)	33-36 (83.9-91.5)	40-43 (101.6-109.3)

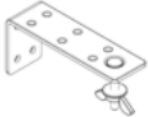
# General Information

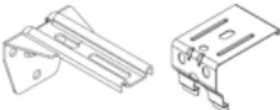
## Bracket Chart: Natural Shades

		No Lift, Continuous Cord Loop, and Motorized	Cordless
	Standard Outside Mount		
	Standard Inside Mount		
<b>Optional</b>	Direct Mount		
	Side Mount		
	Extended New York Tensioner		
	2" Projection Bracket		
	2 5/8" Projection Bracket		
	3 1/2" Projection Bracket		

# General Information

## Continuous Loop Product Detail: Natural Shades

### Standard Roman

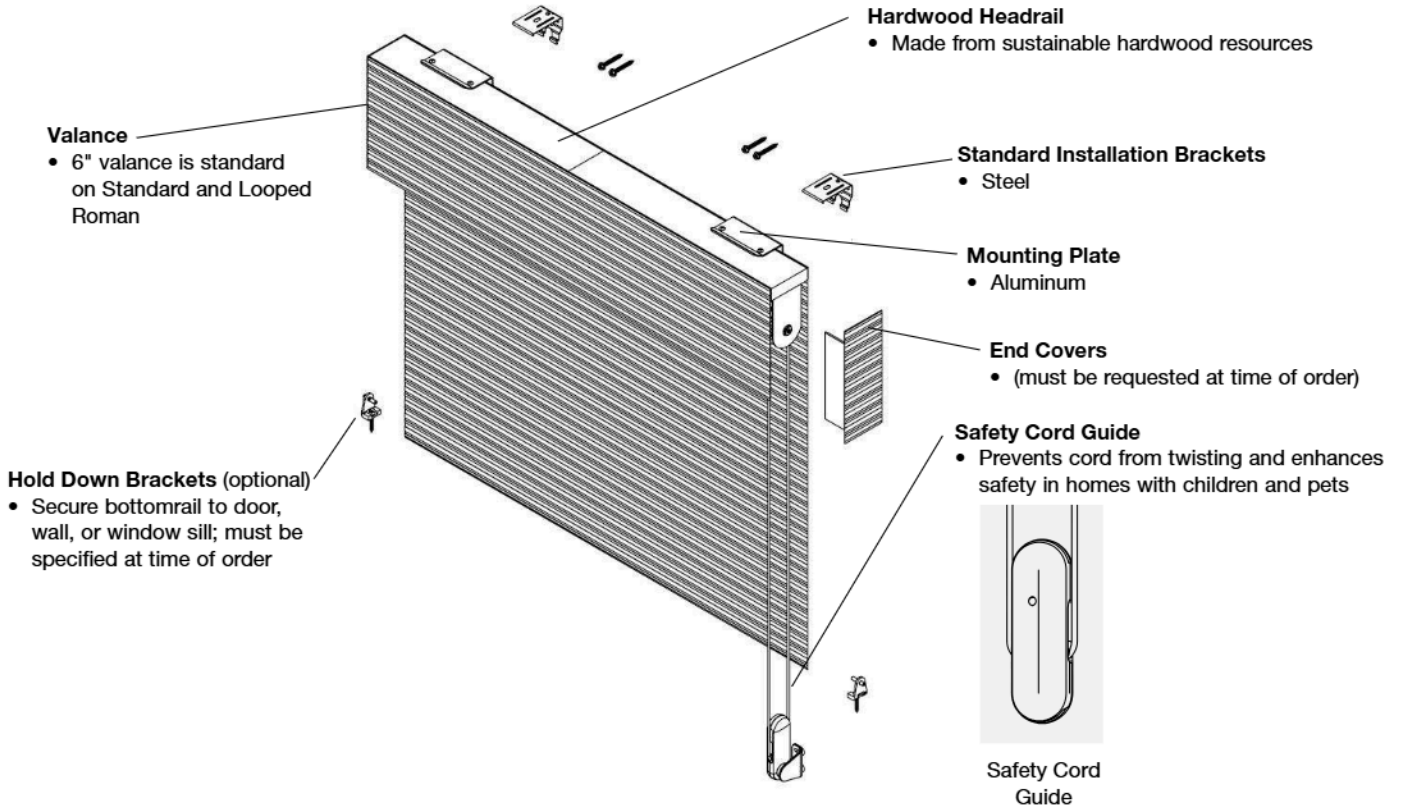

# General Information

## Continuous Loop Product Detail: Natural Shades

### Old Style

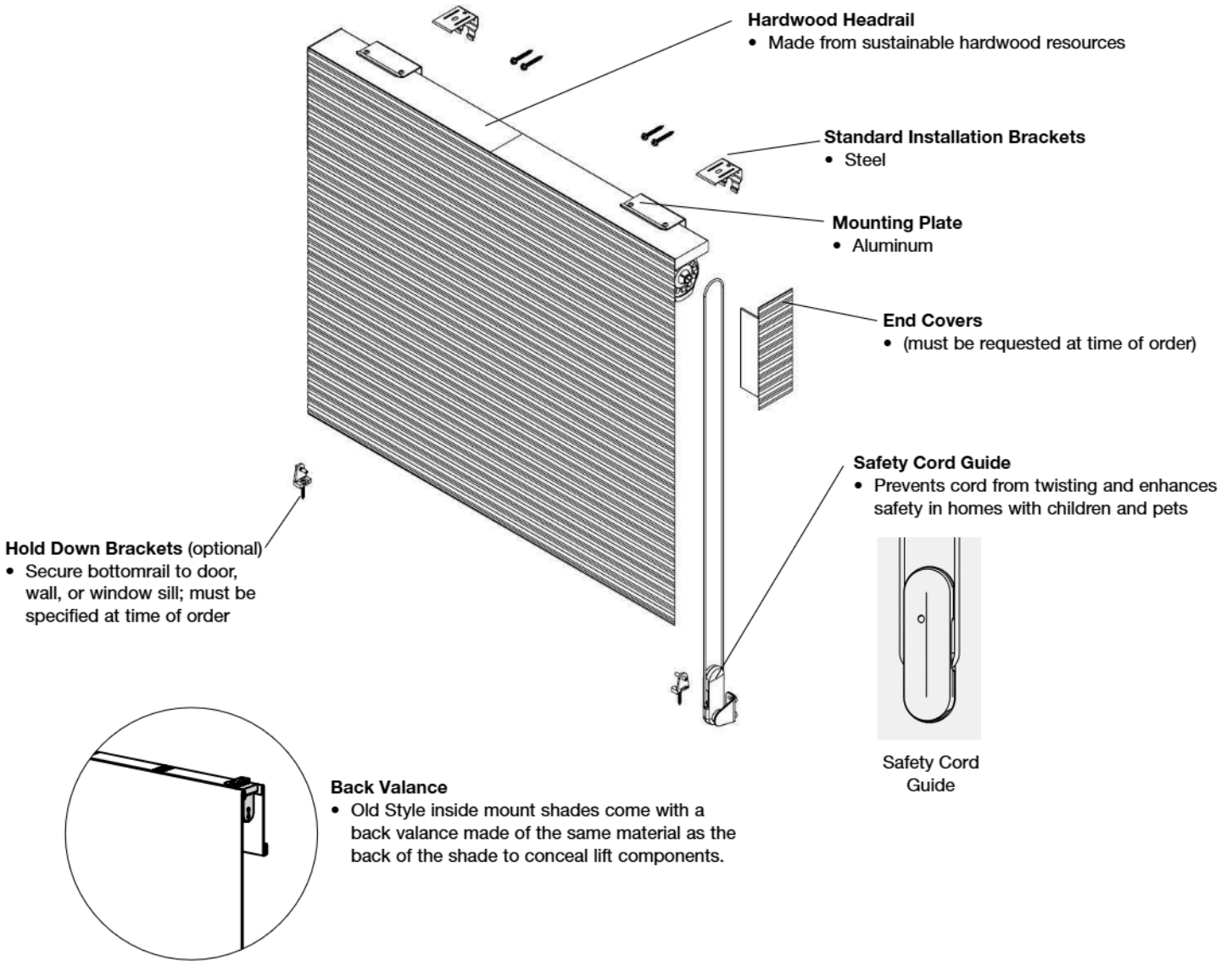

# General Information

## Continuous Loop Product Detail: Natural Shades

### Looped Roman



# General Information

## Cordless Product Detail: Natural Shades

### Standard Roman

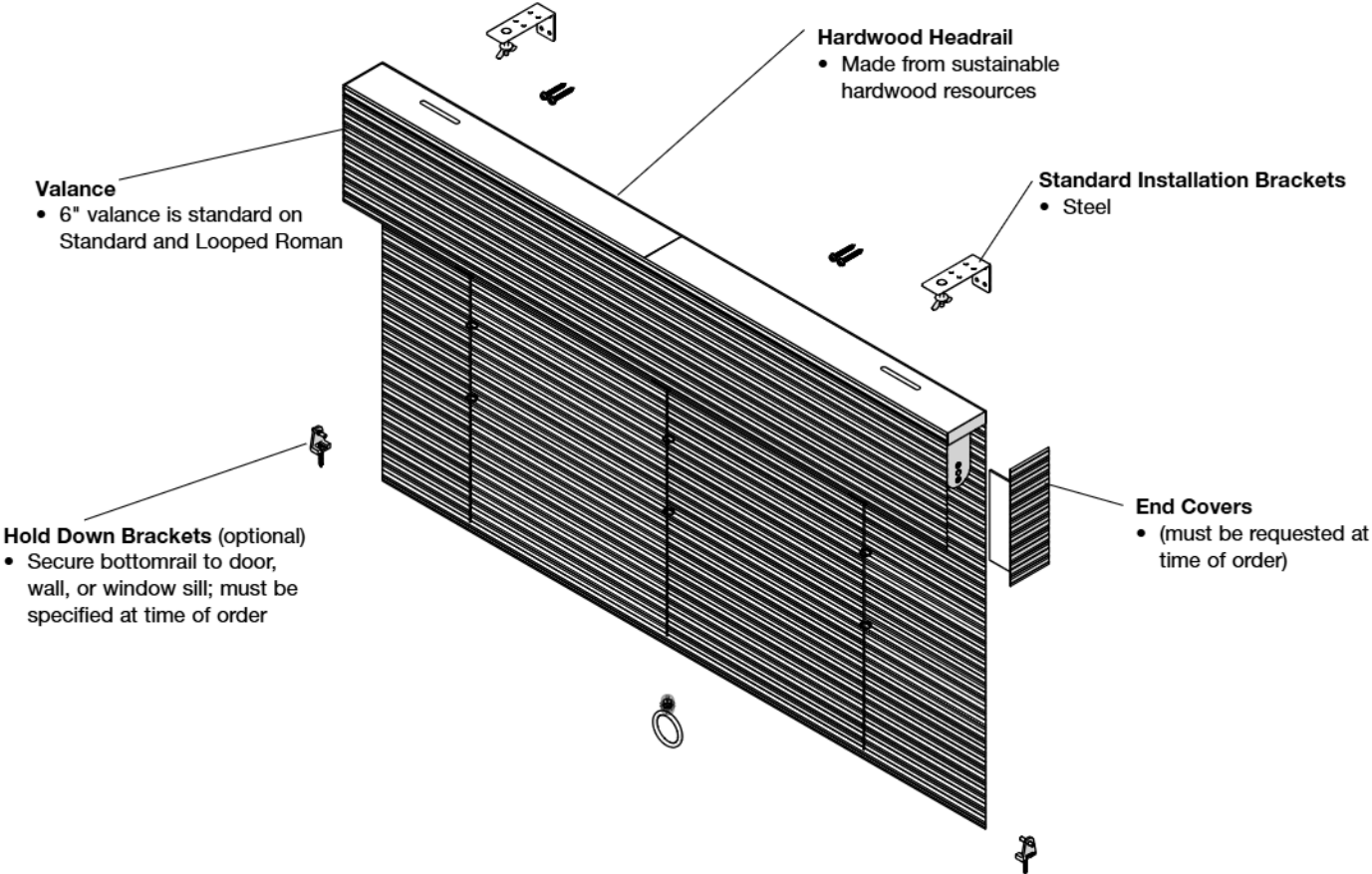

# General Information

## Cordless Product Detail: Natural Shades

### Old Style

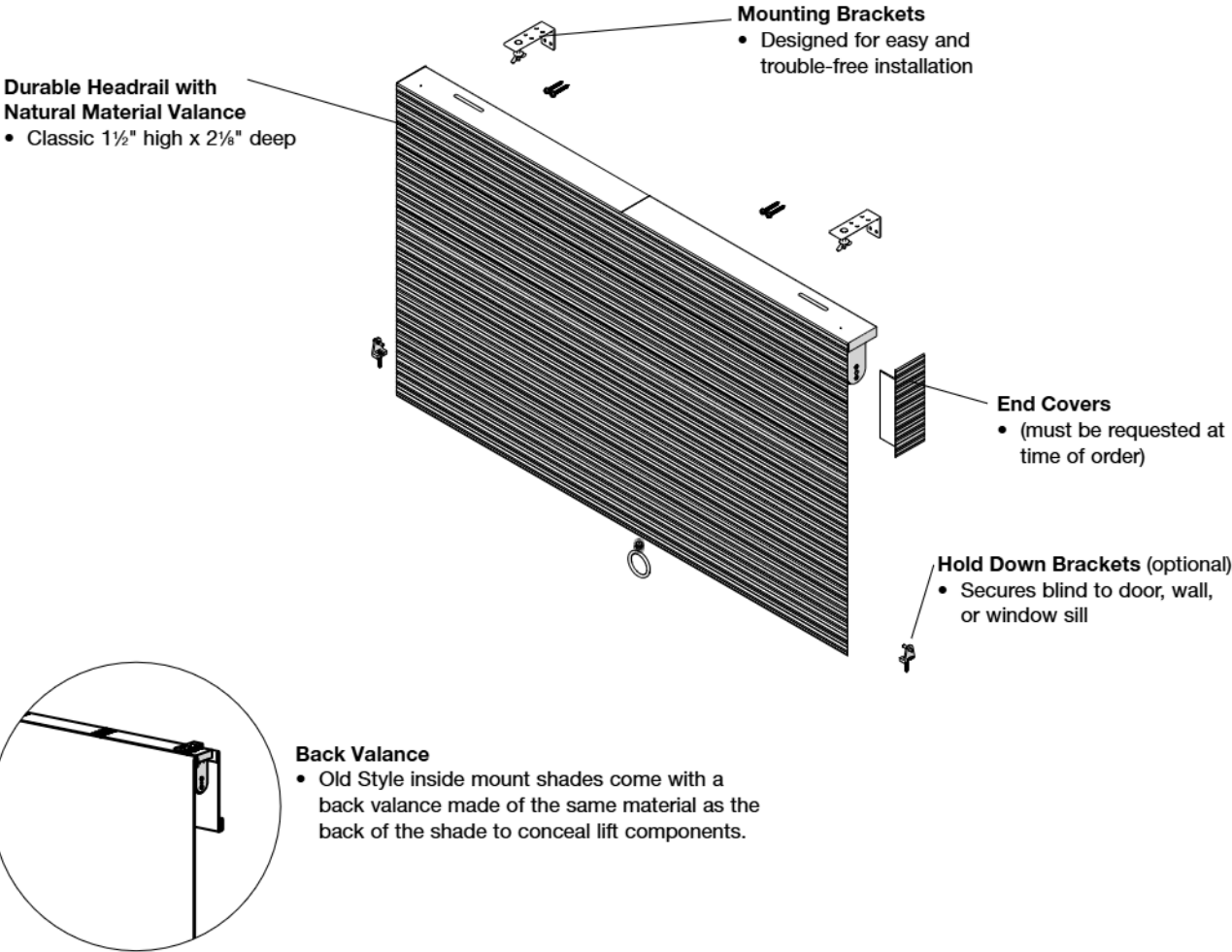

# General Information

## Product Detail: Natural Drapes

### Wand Control

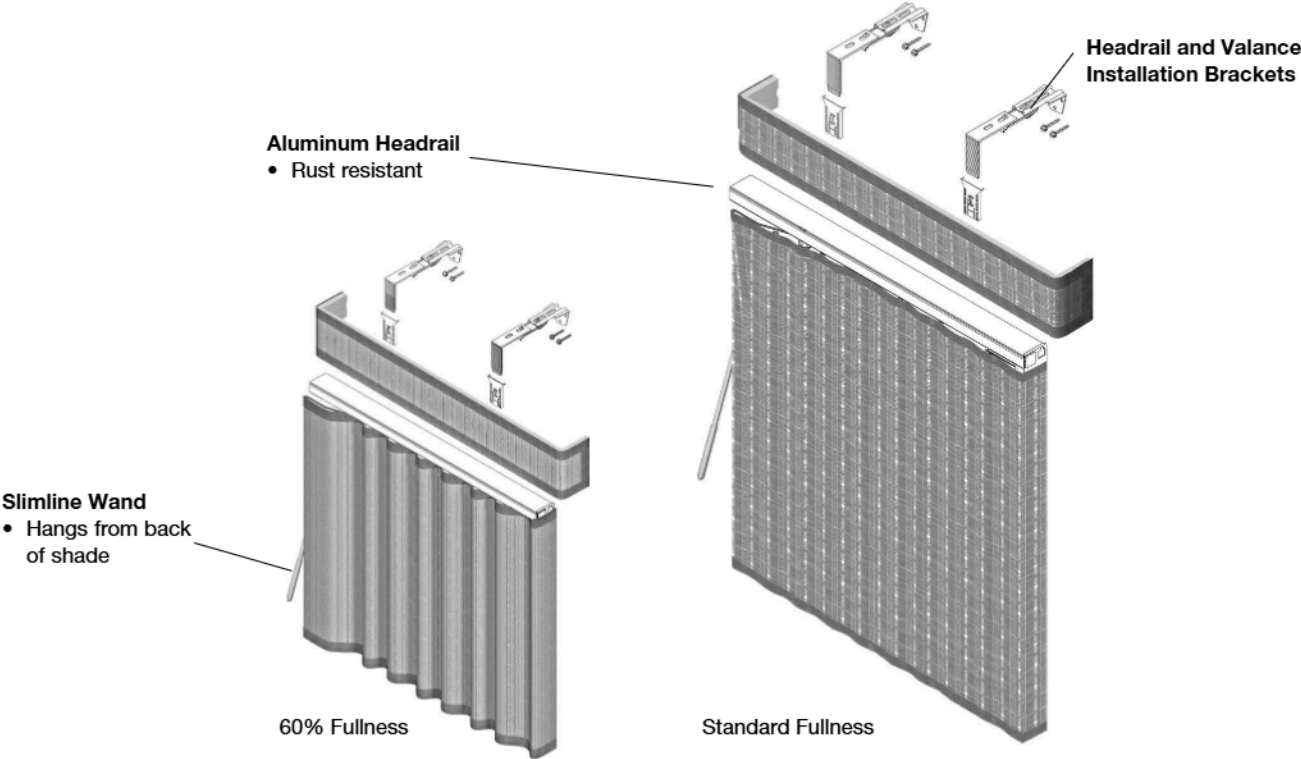

**NOTE:** Natural materials are vertically oriented on the natural drapes and valance.

# Springs Window Fashions Limited Warranty

## WHAT IS COVERED

The product is warranted against original defects in materials or workmanship for the time period specified below, provided that the product was properly installed, the product was made or assembled exclusively from Springs Window Fashions' materials and components, and all Springs Window Fashions' recommendations were followed with regard to limitations and specifications. This warranty extends only to you as the original purchaser of the product.

### Limited Lifetime Warranty

- Cellular shades
- Roller shades
- Solar shades
- Roman shades
- Natural shades
- Pleated shades (with looped tape)
- Sheer shades
- Layered shades
- Wood blinds
- Faux wood blinds\*
- Composite blinds
- Wood shutters
- Composite shutters
- Sliding panels
- 1" and 2" aluminum horizontal blinds
- 2" vinyl horizontal blind headrails and components
- Vertical blind headrails, channel panels, and sheer fabric
- Painted and stained valances
- Painted and stained cornices
- Ladders and cloth tapes

\*Excludes Foundations faux wood blinds (see Five-Year Warranty)

## WHAT IS NOT COVERED

- Unfinished cornices, valances, or Palladian shelves
- Normal wear and tear, including:
  - Loss of color intensity, discoloration, fading, cracking, or yellowing caused by long exposure to direct sunlight
  - Slight color variation
  - Natural variations in color or grain of wood
  - Natural variations, cracking, splitting, twisting, bowing, shrinking, or stretching of organic material used in natural shades
  - Slight warpage of wood blinds or shutters; excessive warpage of wood blinds or shutters caused by moisture or high humidity
- Exterior solar shades damage caused by inclement weather, windy conditions, coastal/salt conditions, pressure washing, or exposure to chemicals including chlorine
- Shutters damage caused by improper maintenance, including sanding, improper washing, and use of razor blades or sealants
- Fabric damage caused by abuse, accidents, alterations, misuse, or failure to follow measuring/installation/use/cleaning/maintenance instructions

## WARRANTY OBLIGATIONS

The obligations of Springs Window Fashions are limited to the replacement or repair of parts or products found to be defective. If repairs are made under this warranty, the repairs will be made with like or similar parts. It is at the sole discretion of Springs Window Fashions to determine whether product will be replaced or repaired.

Springs Window Fashions is not responsible for shipping costs or labor costs, for measuring or taking the product down, or for remeasuring or reinstalling the product.

Springs Window Fashions may defer actions on any claim for warping for a period of up to twelve (12) months from the date of the claim in order to permit acclimating to humidity and temperature conditions.

Warranty coverage applies to defective product only. Other window coverings in the room/household will not be replaced.

THIS WARRANTY IS EXCLUSIVE AND IN LIEU OF ALL OTHER WRITTEN OR ORAL WARRANTIES OR OBLIGATIONS AND LIABILITIES. THE DURATION OF ANY IMPLIED WARRANTIES FOR ANY PRODUCT IS LIMITED IN DURATION TO THE WARRANTY TERM APPLICABLE TO SUCH PRODUCT AS SET FORTH ABOVE.

SPRINGS WINDOW FASHIONS SHALL HAVE NO LIABILITY WHATSOEVER FOR INCIDENTAL, PUNITIVE, OR CONSEQUENTIAL DAMAGES.

Some states do not allow the exclusion or limitation of incidental, punitive or consequential damages, so this limitation or exclusion may not apply to you.

No person is authorized to extend or alter this warranty.

### Five-Year Warranty

- Foundations faux wood blinds
- Motorized components and accessories (batteries not included)
- Exterior solar shades
- Draperies
- Fabric-covered cornices and valances
- Fabric-tailored shades and accessories

### Three-Year Warranty

- Operating cords
- Pleated shades (without looped tape)
- 2" vinyl horizontal blind slats
- Vertical blind vanes

## SERVICE

To learn more about warranty claims, contact customer service at 1-800-221-6352 or [windowfashions@springswf.com](mailto>windowfashions@springswf.com).

Warranty claims must be accompanied by the original sales receipt, along with details regarding the nature of the problem, location of the product, etc. Warranty claims may be submitted to the Customer Service Center at:

Customer Service Center  
Springs Window Fashions, LLC  
8467 Route 405 Highway South  
PO Box 500  
Montgomery, PA 17752-0500